



**MARBLE SYSTEMS<sup>®</sup>**

BATH VANITIES COLLECTION

# MARBLE SYSTEMS®

Since 1982, Marble Systems Inc. has been committed to creating exquisite collections of natural stone. Quarried and processed to exacting specifications using the latest manufacturing technology, our product lines are produced in a wide variety of specialized surface finishes ranging from our smooth Patika and polished lines to our rustic tumbled, chiseled, and antiqued designs.

With distribution and design centers in Washington, D.C., New York, Florida and Los Angeles, Marble Systems is uniquely positioned to provide an extensive supply of the industry's highest quality natural stone products.

Why? Marble Systems is the exclusive distributor of The Tureks Stone Collection, bringing with it the strength of expert quarry and manufacturing operations and the highest levels of quality control, while insuring for the quality, consistency and supply of trade professionals and dealers. We control our stock from the quarry, to the factory, from our warehouse, to your door.

Today, Marble Systems has emerged as the leading choice among top architects, interior designers and discriminating homeowners seeking the finest in natural stone products. Several of our most prestigious projects include: Merrick Plaza in Miami, Trump Plaza in New York, and the Bellagio Casino in Las Vegas.

If you're looking for the finest selection of natural stone, select Marble Systems. The clear leading source for naturally beautiful surfaces.



## BATH VANITIES COLLECTION

Introducing our new line of bath vanities; consisting of beautiful custom designs to enhance your bathrooms from the traditional to the modern. Our cabinets are made of superior quality featuring, a durable box construction which is  $\frac{3}{4}$ " solid wood and soft close doors. The drawers for the vanities are  $\frac{3}{4}$ " plywood dove tail construction, with under-mount glides, and soft close drawers.

All the doors on the vanities are either glazed or painted with kiln-fired lacquer finishes which ensures durability. To ensure flexibility and ease of installation, back panels are cut to allow for ease of installation with plumbing, the interiors of the vanities are all finished to match the boxes, and all sides are flush finished ends.

# BAROQUE

## BATH VANITY COLLECTION



Countertop, sink, & faucet are not included.

### EXTERIOR | FRONT & SIDE VIEW

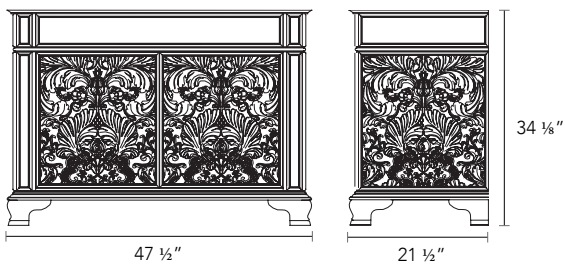

### VANITY DETAILS

- Constructed with yellow poplar hardwood ply
- Fiber glass casting embossed doors with Hettich soft closing concealed steel hinges
- Single pull out drawer located at the base
- Wipe with a mild wet cloth
- Accented with antique brass hardware
- Back panel cut-out for plumbing
- Under mount sink is required
- Pre-assembled
- In stock item
- Handstained finish

### INTERIOR | FRONT VIEW

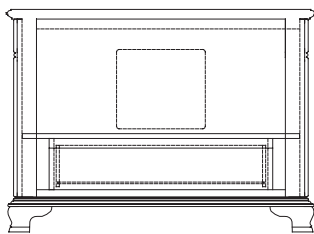

### DIMENSIONS

- Brushed Aluminum (Item PS70054): 29 1/2"W x 31 3/4"L x 34 1/8"H
- Brushed Aluminum (Item PS70053): 35 1/2"W x 21 7/8"L x 34 1/8"H
- Brushed Aluminum (Item PS70018): 47 1/2"W x 21 1/2"L x 34 1/8"H
- Light House Cream (Item PS70016): 47 1/2"W x 21 1/2"L x 34 1/8"H

### FINISH OPTIONS



Brushed Aluminium      Light House Cream



# FEDERALIST

BATH VANITY COLLECTION



Countertop, sink, & faucet are not included.

## EXTERIOR | FRONT & SIDE VIEW

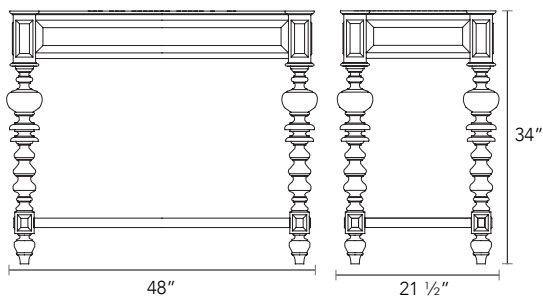

## VANITY DETAILS

- Constructed with yellow poplar hardwood
- Handstained finish
- Wipe with a mild wet cloth
- Under mount sink is required
- Preassembled
- In stock item

## DIMENSIONS

Light Walnut (Item PS70055): 48"W x 21 1/2"L x 34"H  
 Sand Dune Fog (Item PS70056): 48"W x 21 1/2"L x 34"H

## FINISH OPTIONS

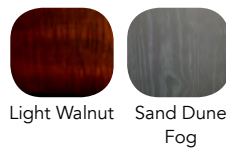

Light Walnut Sand Dune Fog

# GLAMM

BATH VANITY COLLECTION



Countertop, sink, & faucet are not included.

## EXTERIOR | FRONT & SIDE VIEW

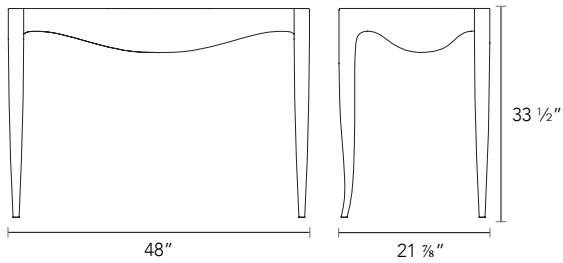

## VANITY DETAILS

- Constructed with yellow poplar hardwood
- Wipe with a soft dry cloth
- Pre-assembled
- In stock item
- Glossy finish

## DIMENSIONS

Fresh White (Item PS70003): 48"W x 21 7/8"L x 33 1/2"H

Windy Sky (Item PS70005): 48"W x 21 7/8"L x 33 1/2"H

Midnight Black (Item PS70004): 48"W x 21 7/8"L x 33 1/2"H

## FINISH OPTIONS



Fresh White

Windy Sky

Midnight Black

# MALABAR

BATH VANITY COLLECTION



Countertop, sink, & faucet are not included.

## EXTERIOR | FRONT & SIDE VIEW

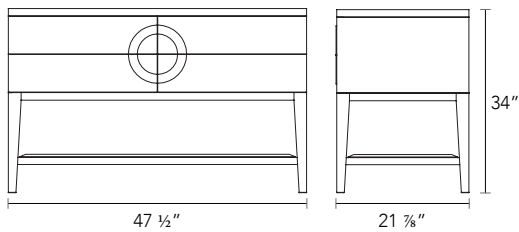

## DRAWER & MEDICINE CABINET LAY-OUT

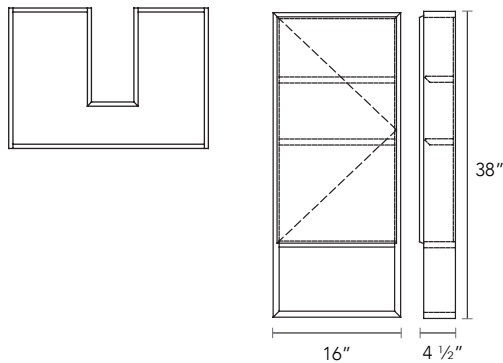

## VANITY DETAILS

- Constructed with yellow poplar hardwood ply
- High-gloss painted doors with Hettich soft closing concealed steel hinges
- Single pull out drawer located at the base
- Wipe with a soft dry cloth
- Under mount sink is required
- Preassembled
- In stock item
- Handstained finish

## MEDICINE CABINET DETAILS

- Constructed with yellow poplar hardwood ply
- High-gloss painted doors

## DIMENSIONS

- Mahogany Antique/Linen White (Item PS70025): 28"W x 21"L x 33 1/4"H
- Mahogany Antique/Linen White (Item PS70074): 34"W x 21"L x 33 1/4"H
- Mahogany Antique/Linen White (Item PS70075): 47 1/2"W x 21 7/8"L x 34"H

## MEDICINE CABINET

- Linen White (Item PS70051): 16"W x 4 1/2"L x 38"H

## FINISH OPTIONS

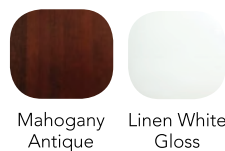

# MELROSE

BATH VANITY COLLECTION



Countertop, sink, & faucet are not included.

## EXTERIOR | FRONT & SIDE VIEW

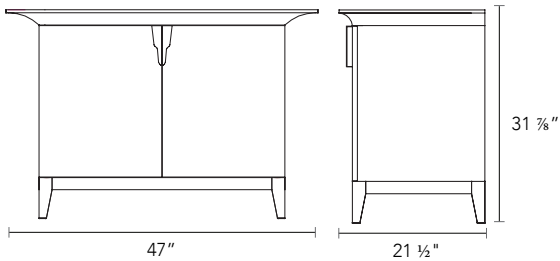

## INTERIOR | FRONT VIEW

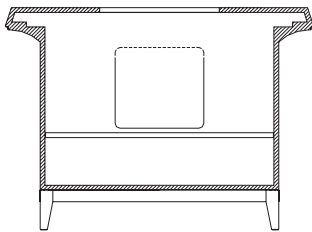

## VANITY DETAILS

- Constructed with yellow poplar hardwood ply
- Wipe with a mild wet cloth
- Matte finish doors with Hettich soft closing concealed steel hinges
- Back panel cut-out for plumbing purposes
- Single fixed shelf inside
- Pre-assembled
- In stock item

## DIMENSIONS

Sand Dune Sahara (Item PS70052): 35 1/8"W x 21 1/2"L x 31 7/8"H

Sand Dune Sahara (Item PS70026): 47"W x 21 1/2"L x 31 7/8"H

Sand Dune Tan (Item PS70027): 47"W x 21 1/2"L x 31 7/8"H

## FINISH OPTIONS

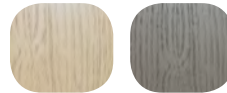

Sand Dune  
Tan

Sand Dune  
Sahara



# MONDRIAN

BATH VANITY COLLECTION



Countertop, sink, & faucet are not included.

## EXTERIOR | FRONT & SIDE VIEW

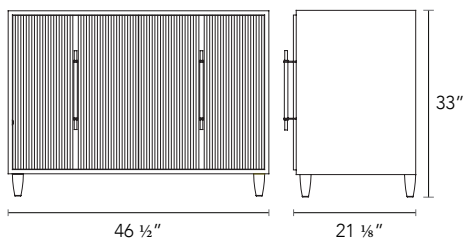

## VANITY DETAILS

- Constructed with yellow poplar hardwood ply
- Wooden legs and fiber glass casting corrugated doors with Hettich soft closing concealed steel hinges
- Pull-out drawer(s) located at the base
- Wipe with a soft dry cloth
- Under mount sink is required
- Back panel cut-out for plumbing
- Pre-assembled
- In stock item

## DIMENSIONS

- Fresh White (Item PS70068): 28 1/2"W x 21 3/4"L x 33 1/2"H
- Fresh White (Item PS70069): 34 1/2"W x 21 5/8"L x 33 1/2"H
- Fresh White (Item PS70036): 46 1/2"W x 21 1/8"L x 33"H
- Linen White Gloss/Linen White Matte (Item PS70070): 28 1/2"W x 21 3/4"L x 33 1/2"H
- Linen White Gloss/Linen White Matte (Item PS70071): 34 1/2"W x 21 1/2"L x 33 1/2"H
- Linen White Gloss/Linen White Matte (Item PS70034): 46 1/2"W x 21 1/8"L x 33"H
- Linen White Gloss/Light Walnut (Item PS70072): 28 5/8"W x 21 3/4"L x 33 1/2"H
- Linen White Gloss/Light Walnut (Item PS70073): 34 1/2"W x 21 3/4"L x 33 1/2"H
- Linen White Gloss/Light Walnut (Item PS70035): 46 1/2"W x 21 1/8"L x 33"H

## INTERIOR | FRONT VIEW

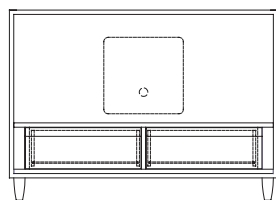

## FINISH OPTIONS

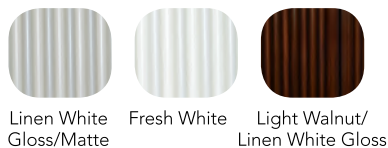

# MUSTIQUE

BATH VANITY COLLECTION



Countertop, sink, & faucet are not included.

## EXTERIOR | FRONT & SIDE VIEW

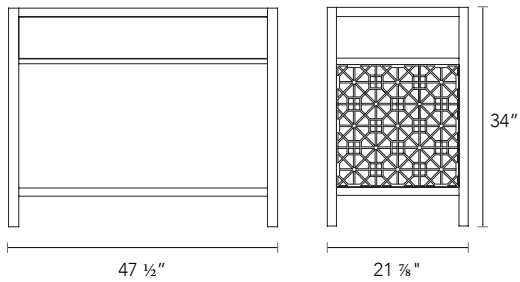

## VANITY DETAILS

- Constructed with yellow poplar hardwood ply
- Wipe with a soft dry cloth
- Kilm and fired high gloss finish
- Pre-assembled
- In stock item

## DIMENSION

Fresh White (Item Code PS70061): 47 1/2"W x 21 7/8"L x 34"H

## FINISH OPTION



Fresh White

# NEWTON

BATH VANITY COLLECTION



Countertop, sink, & faucet are not included.

## EXTERIOR | FRONT & SIDE VIEW

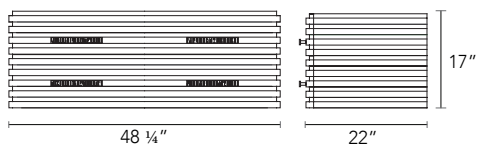

## Drawer Top Layout

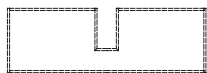

## VANITY DETAILS

- Hardwood ply with wooden strip construction
- Metal Bracket included for wall placement
- Soft closing sliding drawers accented with solid brass pull handles
- Wipe with a mild wet cloth
- Under mount sink is required
- Pre-assembled
- In stock item

## DIMENSION

Bourneville Distress (Item PS70019): 48 1/4"W x 22"L x 17"H

## FINISH OPTION

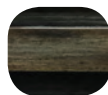

Bourneville  
Distress



# PAVILLION

BATH VANITY COLLECTION



Countertop, sink, & faucet are not included.

## EXTERIOR | FRONT & SIDE VIEW

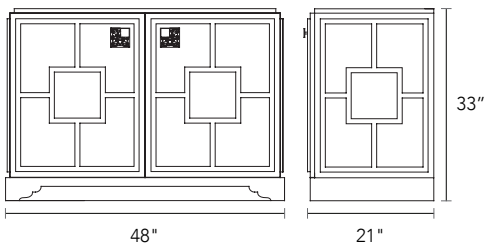

## INTERIOR | FRONT VIEW

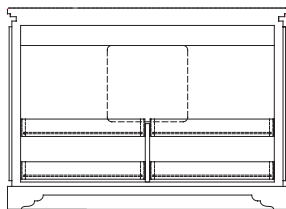

## VANITY DETAILS

- Constructed with yellow poplar and hardwood ply panels
- Wipe with a soft dry cloth
- Kilm and fired high gloss finish
- Fret work design on fiber glass doors accented with solid brass chrome finish pulls
- Pull-out drawer(s) located at the base
- Pre-assembled
- In stock item

## DIMENSIONS

Fresh White (Item Code PS70061): 48"W x 21"L x 33"H

## FINISH OPTION





# SEINA

BATH VANITY COLLECTION



Countertop, sink, & faucet are not included.

## EXTERIOR | FRONT & SIDE VIEW

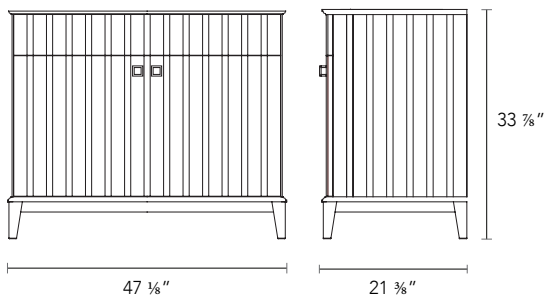

## INTERIOR | FRONT VIEW

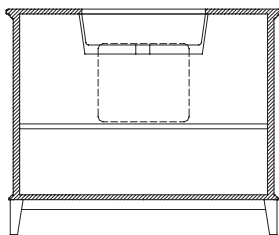

## VANITY DETAILS

- Constructed with yellow poplar and hardwood ply
- Fixed shelf inside
- Stainless steel hardware
- Wipe with a mild wet cloth for Onyx White
- Wipe with a soft dry cloth for Fresh White
- Back panel cut-out for plumbing
- Under mount sink is required
- Preassembled
- In stock item

## DIMENSIONS\*

- Fresh White (Item PS70059): 29 1/8"W x 21 1/2"L x 34"H
- Fresh White (Item PS70060): 47 1/8"W x 21 3/8"L x 33 7/8"H
- Onyx Oak (Item PS70057): 29 1/8"W x 21 1/4"L x 34"H
- Onyx Oak (Item PS70058): 47 1/8"W x 21 3/8"L x 33 7/8"H

## FINISH OPTIONS



SLOANE  
BATH VANITY COLLECTION



# SLOANE

## EXTERIOR | FRONT & SIDE VIEW

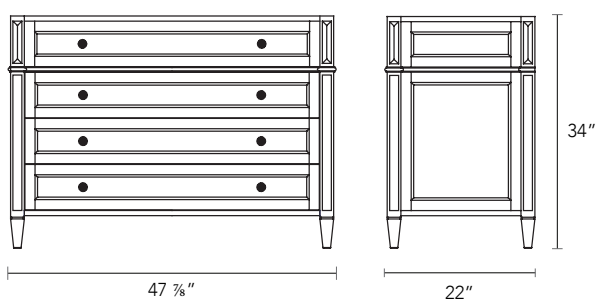

## UPPER DRAWER LAYOUT

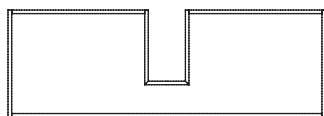

## VANITY DETAILS

- Constructed with yellow poplar and hardwood ply
- 3 full extension drawers and one false drawer located at the top
- Solid brass hardware
- Wipe with a mild wet cloth
- Back panel cut-out for plumbing
- Under mount sink is required
- Preassembled
- In stock item

## DIMENSIONS\*

- Sand Dune Fog (Item PS70067): 35 3/4"W x 21 3/8"L x 29 1/2"H
- Sand Dune Fog (Item PS70022): 47 7/8"W x 22"L x 34"H
- Sand Dune Gargoyle (Item PS70024): 29 3/4"W x 21 3/8"L x 29 1/2"H
- Sand Dune Gargoyle (Item PS70064): 35 1/8"W x 21 1/2"L x 29 1/2"H
- Sand Dune Gargoyle (Item PS70065): 47 7/8"W x 22"L x 34"H
- Cedar Skin (Item PS70023): 30"W x 22"L x 34 1/2"H

## FINISH OPTIONS

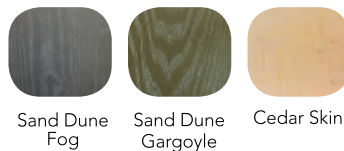





[www.marblesystems.com](http://www.marblesystems.com)

Copyright © 2015 Marble Systems, Inc. No part of this book may be reproduced by any means for commercial purposes.  
Marble Systems will vigorously protect this and all other copyrights noted in this book.